

# G1

## PLASTIC TUBES

Plastic tubes with a round head with a diameter of 50 mm, made from high quality polypropylene copolymer.

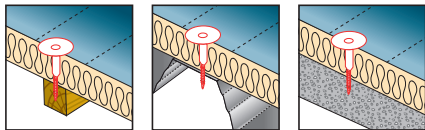
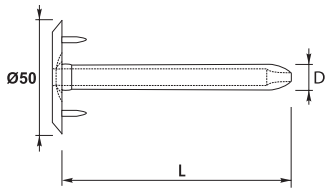

Designed for fastening insulation materials on flat roof applications, in combination with screws of type GTS-S, GTS-B, GTHD. Additional spikes provide higher bearing capacity of the connection tube-membrane.

Product designation	Tube					Package Separate/Quantity/Collective [pcs]
	Plate diameter	Tube diameter	Length	Min. insulation thickness		
	D	d	L	Polystyrene, pir	Wool	
	[mm]	[mm]	[mm]	[mm]	[mm]	
PG145035	50	14,5	35	50	50	500/1/500
PG145065	50	14,5	65	80	80	500/1/500
PG145085	50	14,5	85	100	100	500/1/500
PG145105	50	14,5	105	120	120	400/1/400
PG145135	50	14,5	135	150	150	250/1/250
PG145165	50	14,5	165	180	190	250/1/250
PG145185	50	14,5	185	200	210	200/1/200
PG145235	50	14,5	235	250	270	150/1/150
PG145285	50	14,5	285	300	320	125/1/125
PG145335	50	14,5	335	350	380	60/1/60
PG145385	50	14,5	385	400	430	40/1/40
PG145435	50	14,5	435	450	490	40/1/40

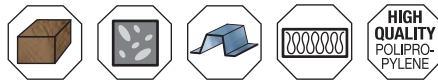

**product for special order**

# G2

## PLASTIC TUBES

Plastic tubes with a round head with a diameter of 50 mm, made from high quality polypropylene copolymer.

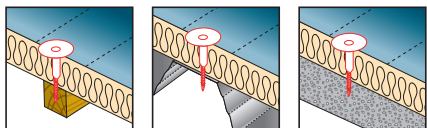
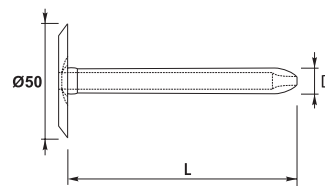

Designed for fastening insulation materials on flat roof applications, in combination with screws of type GTS-S, GTS-B, GTHD.

Product designation	Tube					Package Separate/Quantity/Collective [pcs]
	Plate diameter	Tube diameter	Length	Min. insulation thickness		
	D	d	L	Polystyrene, pir	Wool	
	[mm]	[mm]	[mm]	[mm]	[mm]	
PG245035	50	14,5	35	50	50	500/1/500
PG245065	50	14,5	65	80	80	500/1/500
PG245085	50	14,5	85	100	100	500/1/500
PG245105	50	14,5	105	120	120	400/1/400
PG245135	50	14,5	135	150	150	250/1/250
PG245165	50	14,5	165	180	190	250/1/250
PG245185	50	14,5	185	200	210	200/1/200
PG245235	50	14,5	235	250	270	150/1/150
PG245285	50	14,5	285	300	320	125/1/125
PG245335	50	14,5	335	350	380	60/1/60
PG245385	50	14,5	385	400	430	40/1/40
PG245435	50	14,5	435	450	490	40/1/40

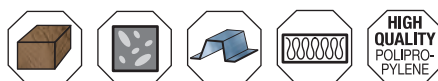

Screws made of surface-hardened carbon steel, with a drilling tip, fine thread, and bugle head with PH2 slot. Covered with an additional gRey.coat corrosion protection coat.

# GTS-S

SELF-TAPPING INSULATION SCREWS

Designed for fastening insulation materials in applications of flat roofs in combination with a plastic tube for corrugated structural steel sheets (up to 2 x 0.88 mm). In combination with expansion sleeve for concrete construction.



Product designation	Fastener				Max drill. thick.	Min. drill. thick.	Package				
	D	L	L1	PH			DC	T	Indiv. *GC0PL	Indiv. *GC3PL	Quantity
	[mm]	[mm]	[mm]		[mm]	[mm]	[mm]	[pcs]	[pcs]	[pcs]	[pcs]
P152050GC0PL	4,8	50	45	2	2 x 0,88	0,60	1000	-	1	1000	-
P152060GC0PL	4,8	60	50	2	2 x 0,88	0,60	500	-	1	500	-
P152070GC0PL	4,8	70	60	2	2 x 0,88	0,60	500	-	1	500	-
P152080GC0PL	4,8	80	70	2	2 x 0,88	0,60	500	-	1	500	-
P152090GC0PL	4,8	90	80	2	2 x 0,88	0,60	500	-	1	500	-
P152100GC0PL	4,8	100	80	2	2 x 0,88	0,60	500	100	1	500	100
P152110GC0PL	4,8	110	80	2	2 x 0,88	0,60	500	100	1	500	100
P152120GC0PL	4,8	120	80	2	2 x 0,88	0,60	500	100	1	500	100
P152130GC0PL	4,8	130	80	2	2 x 0,88	0,60	500	100	1	500	100
P152140GC0PL	4,8	140	80	2	2 x 0,88	0,60	500	100	1	500	100
P152150GC0PL	4,8	150	80	2	2 x 0,88	0,60	500	100	1	500	100
P152160GC0PL	4,8	160	80	2	2 x 0,88	0,60	500	100	1	500	100
P152170GC0PL	4,8	170	80	2	2 x 0,88	0,60	500	100	1	500	100
P152180GC0PL	4,8	180	80	2	2 x 0,88	0,60	500	100	1	500	100
P152200GC0PL	4,8	200	80	2	2 x 0,88	0,60	500	100	1	500	100
P152220GC0PL	4,8	220	80	2	2 x 0,88	0,60	500	100	1	500	100
P152240GC0PL	4,8	240	80	2	2 x 0,88	0,60	500	100	1	500	100
P152260GC0PL	4,8	260	80	2	2 x 0,88	0,60	500	100	1	500	100
P152280GC0PL	4,8	280	80	2	2 x 0,88	0,60	500	100	1	500	100
P152300GC0PL	4,8	300	80	2	2 x 0,88	0,60	500	100	1	500	100

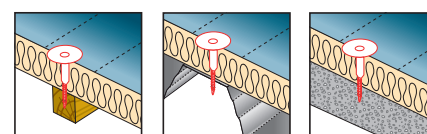
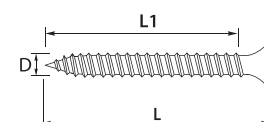
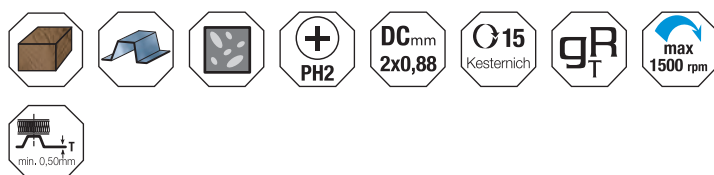

# GTS-B

DRILLING, SELF-TAPPING  
INSULATION SCREWS

Drilling, self-tapping screws made of surface-hardened carbon steel, with a reduced drilling point, fine thread, and bugle head with PH2 or TORX25 slot. Covered with an additional gRey.coat corrosion protection coat.

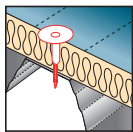
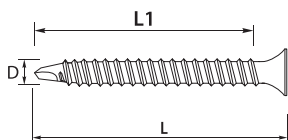

Designed for fastening insulation materials in applications of flat roofs in combination with a plastic tube for corrugated structural steel sheets (up to 2 x 1.25 mm)

Product designation	Fastener				Max drill.thick. DC	Min drill.thick. T	Package Separate/ Quantity/Collective [pcs]
	D	L	L1	Type			
	[mm]	[mm]	[mm]		[mm]	[mm]	
P153050GC0PL	4,8	50	45	PH2	2 x 1,25	0,7	1000/1/1000
P153060GC0PL	4,8	60	50	PH2	2 x 1,25	0,7	500/1/500
P153070GC0PL	4,8	70	50	PH2	2 x 1,25	0,7	500/1/500
P153080GC0PL	4,8	80	50	PH2	2 x 1,25	0,7	500/1/500
P153091GC0PL	4,8	90	50	PH2	2 x 1,25	0,7	500/1/500
P153100GC0PL	4,8	100	50	PH2	2 x 1,25	0,7	500/1/500
P153109GC0PL	4,8	110	50	PH2	2 x 1,25	0,7	500/1/500
P153120GC0PL	4,8	120	50	PH2	2 x 1,25	0,7	500/1/500
P153130GC0PL	4,8	130	50	PH2	2 x 1,25	0,7	500/1/500
P153140GC0PL	4,8	140	50	PH2	2 x 1,25	0,7	500/1/500
P153149GC0PL	4,8	150	50	PH2	2 x 1,25	0,7	500/1/500
P153109GC3PL	4,8	110	50	PH2	2 x 1,25	0,7	100/1/100
P153120GC3PL	4,8	120	50	PH2	2 x 1,25	0,7	100/1/100
P153130GC3PL	4,8	130	50	PH2	2 x 1,25	0,7	100/1/100
P153140GC3PL	4,8	140	50	PH2	2 x 1,25	0,7	100/1/100
P153149GC3PL	4,8	150	50	PH2	2 x 1,25	0,7	100/1/100
P153180GC3PL	4,8	180	50	PH2	2 x 1,25	0,7	100/1/100
P153210GC3PL	4,8	210	50	PH2	2 x 1,25	0,7	100/1/100
P153240GC3PL	4,8	240	50	PH2	2 x 1,25	0,7	100/1/100
P153280GC3PL	4,8	280	50	PH2	2 x 1,25	0,7	100/1/100
P153300GC3PL	4,8	300	50	PH2	2 x 1,25	0,7	100/1/100
P153050T25GC0PL	4,8	50	45	T25	2 x 1,25	0,7	1000/1/1000
P153060T25GC0PL	4,8	60	50	T25	2 x 1,25	0,7	500/1/500
P153070T25GC0PL	4,8	70	50	T25	2 x 1,25	0,7	500/1/500
P153080T25GC0PL	4,8	80	50	T25	2 x 1,25	0,7	500/1/500
P153090T25GC0PL	4,8	90	50	T25	2 x 1,25	0,7	500/1/500
P153100T25GC0PL	4,8	100	50	T25	2 x 1,25	0,7	500/1/500
P153110T25GC3PL	4,8	110	50	T25	2 x 1,25	0,7	100/1/100
P153120T25GC3PL	4,8	120	50	T25	2 x 1,25	0,7	100/1/100
P153130T25GC3PL	4,8	130	50	T25	2 x 1,25	0,7	100/1/100
P153140T25GC3PL	4,8	140	50	T25	2 x 1,25	0,7	100/1/100
P153150T25GC3PL	4,8	150	50	T25	2 x 1,25	0,7	100/1/100
P153180T25GC3PL	4,8	180	50	T25	2 x 1,25	0,7	100/1/100
P153210T25GC3PL	4,8	210	50	T25	2 x 1,25	0,7	100/1/100
P153300T25GC3PL	4,8	300	50	T25	2 x 1,25	0,7	100/1/100



Screws made of surface-hardened carbon steel, with a reduced drilling point, fine thread, and a hex washer head. Covered with an additional gRey.coat corrosion protection coat.

## GTS-BZT

DRILLING, SELF-TAPPING INSULATION SCREWS (DOUBLE THREAD)

Designed for fastening insulation materials in applications of flat roofs in combination with a recessed decking plate for corrugated structural steel sheets (up to 2 x 1.25 mm).

Product designation	Fastener				Max drill. thick.	Min drill. thick.	Package Separate/Quantity/Collective [pcs]
	D	L	L1	SW			
	[mm]	[mm]	[mm]	[mm]	DC	T	
P154080GC0PL	4,8	80	60	8	2 x 1,25	0,75	500/1/500
P154100GC0PL	4,8	100	60	8	2 x 1,25	0,75	500/1/500
P154120GC0PL	4,8	120	60	8	2 x 1,25	0,75	500/1/500
P154140GC0PL	4,8	140	60	8	2 x 1,25	0,75	500/1/500



product for special order

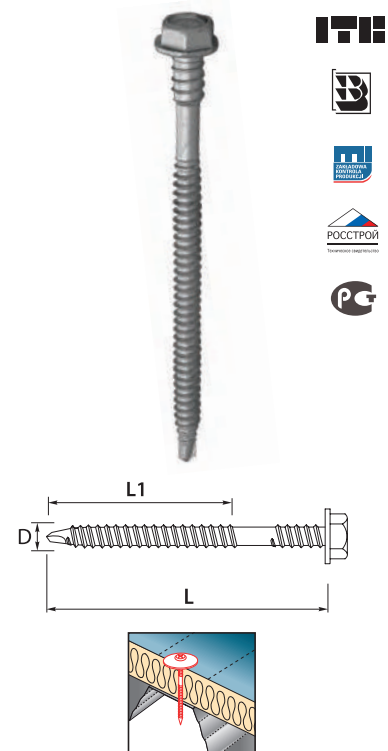

Screws made of surface-hardened carbon steel, with a Ricoh drilling point, loose thread, and bugle head with TORX 25 slot. Covered with an additional gRey.coat corrosion protection coat.

## GTHD

INSULATION SCREWS FOR CONCRETE CONSTRUCTION

Designed for fastening insulation materials on flat roof applications, in combination with a plastic tube for concrete and wooden structure.

Product designation	Fastener				Anchoring depth		Package Separate/Quantity/Collective [pcs]
	D	L	L1	TX	H [mm]		
	[mm]	[mm]	[mm]		Concrete	Wood	
P156060GC0PL	6,3	60	31	25	30	30	500/1/500
P156070GC0PL	6,3	70	41	25	30	30	500/1/500
P156080GC0PL	6,3	80	51	25	30	30	500/1/500
P156090GC0PL	6,3	90	61	25	30	30	500/1/500
P156100GC0PL	6,3	100	61	25	30	30	500/1/500
P156130GC0PL	6,3	130	61	25	30	30	500/1/500
P156160GC0PL	6,3	160	61	25	30	30	500/1/500
P156180GC0PL	6,3	180	61	25	30	30	500/1/500
P156200GC0PL	6,3	200	61	25	30	30	500/1/500
P156220GC0PL	6,3	220	61	25	30	30	500/1/500
P156250GC0PL	6,3	250	61	25	30	30	500/1/500
P156280GC0PL	6,3	280	61	25	30	30	500/1/500
P156300GC0PL	6,3	300	61	25	30	30	500/1/500

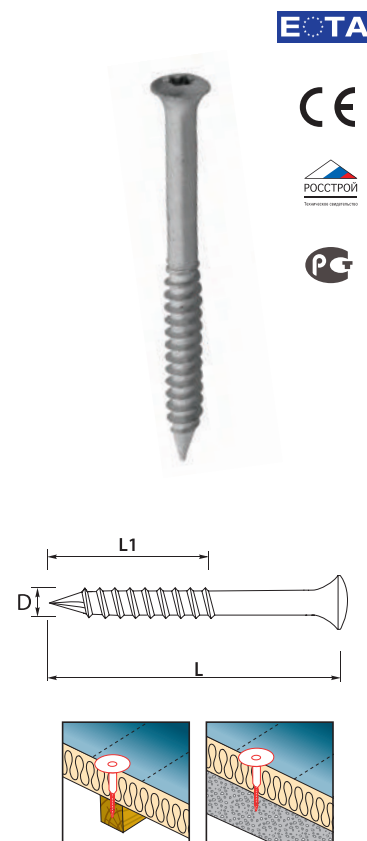

# U-ZK

EXPANSION SLEEVES FOR CONCRETE

Nylon sleeves with a collar made of high quality polyamide.



Designed for fastening insulation materials on concrete in applications of flat roofs in combination with GTS-S screw. Long expansion zone ensures proper attachment even in lower grade concrete.

Product designation	Fastener			Package Separate/Quantity/Collective [pcs]
	Type	L	D	
		[mm]	[mm]	
PBP80570PL	U-ZK	60	8,0	200/4/800

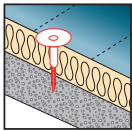
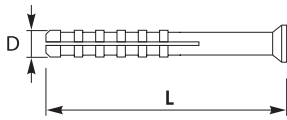

# DVP

RECESSED, ROUND DECKING PLATES

Round insulation decking plates made of steel sheet, covered with aluminum-zinc corrosion coating.

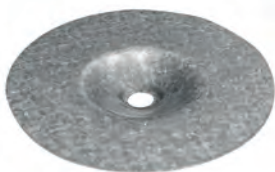

Designed for fastening insulation materials on flat roof applications, in combination with insulation screws.

Product designation	Washer			Package Separate/Quantity/Collective [pcs]
	D	H	d	
	[mm]	[mm]	[mm]	
PDVPEF5010D	50	1,0	7,0	1000/1/1000
PDVPEF7010D	70	1,0	7,0	500/1/500

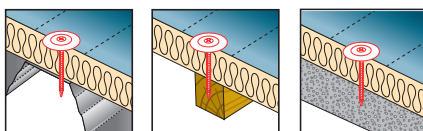
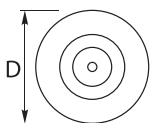

Oval insulation decking plates made of steel sheet, covered with aluminum-zinc corrosion coating.

## DVP

RECESSED, OVAL INSULATION DECKING PLATES

Designed for fastening insulation materials on flat roof applications, in combination with insulation screws.



Product designation	Washer				Package Separate/Quantity/Collective [pcs]
	D	L	H	d	
	[mm]	[mm]	[mm]	[mm]	
PDVPEF8040D	40	80	1,0	7	500/1/500

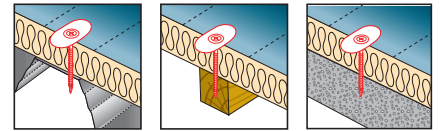
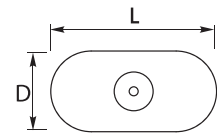

Round insulation decking plates made of steel sheet, covered with aluminum-zinc corrosion coating.

## DVP

ROUND FLAT INSULATION DECKING PLATES

Designed for fastening insulation materials on flat roof applications, in combination with insulation screws.



Product designation	Washer			Package Separate/Quantity/Collective [pcs]
	D	H	d	
	[mm]	[mm]	[mm]	
PDVPEF4010N	40	1,0	7,0	1000/1/1000
PDVPEF5010N	50	1,0	7,0	1000/1/1000
PDVPEF7010N	70	1,0	7,0	500/1/500

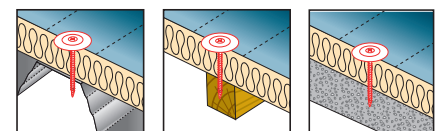
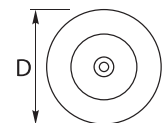

# DVP

FLAT, OVAL INSULATION  
DECKING PLATES

Oval insulation decking plates made of steel sheet, covered with aluminum-zinc corrosion coating.



Designed for fastening insulation materials on flat roof applications, in combination with insulation screws.

Product designation	Washer				Package Separate/Quantity/Collective [pcs]
	D	L	H	d	
	[mm]	[mm]	[mm]	[mm]	
PDVPEF8040N	40	80	1,0	7,0	500/1/500

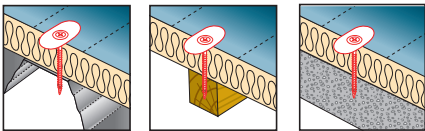
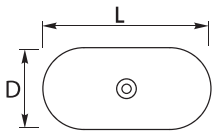

# SCREWDRIVER BITS PH2

Screwdrivers bits are made of high quality chrome vanadium steel, surface hardened, protected from corrosion.

Designed for use in screwdrivers. Used for correct screwing fasteners into the structure material.



Product designation	Bit		Package Separate/Quantity/Collective [pcs]
	L	Type	
	[mm]		
P189515	150	PH2	1/1/1
P189520	200	PH2	1/1/1
P189525	250	PH2	1/1/1
P189530	300	PH2	1/1/1
P189535	350	PH2	1/1/1

